

CORNELL

LUNATIC

Fall 2011 - Campus Humor Magazine - Free



The Disaster Issue

Letter From the Editor

Oh hello! I didn't see you there...

What you have before you is by far, the best and most comprehensive issue of the Cornell Lunatic ever produced in the history of our illustrious university. Some of you voluntarily asked to have a copy of this magazine, being longtime fans of our esteemed publication. And we thank you for your patronage.

The vast majority of you however, had this magazine thrust into your hands like individual lubricated condoms at the end of a sex-ed lecture. You didn't really want one at the time, but a few weeks later you were super happy to have one handy. Trust me, once you read even one page of this baby, you'll be pregnant with anticipation to read

the rest of it. It's that good. (Disclaimer: Don't use this magazine as a method of birth-control. Tests have proven that carrying around a copy of the Cornell Lunatic makes you 53% more attractive. To everyone.)

That being said, welcome to our Disaster issue of the Lunatic! What with the economy in shambles, earthquakes running rampant and hurricanes tearing up the United States like giant angry BeyBlades of destruction, it was only fitting to make light of all sorts of terrible catastrophes. So before the next calamity hits us, let's get a good laugh out of it.

Most Sincerely,

Elliot Mandel

The Staff

Editor in Chief

Elliot Mandel

Executive Editor

John Flanagan

Associate Editor

Leela Chantrelle

Business Manager

Billy Kurinskas

Art Editor

Thora Bjorndottir

Layout Editor

Elizabeth Parcher

Sergeant at Arms

Roselle Bajet

Everyone Else

Chris Boyer

David Clark

Daniel Lewis

Gavin Acres

Iryna Ivasyk

Margaret Fleming

Rachel Karcher

Thomas Pagani

Emily Choi

Aaron Stolicker

The Old Guys

Ben Strauss

Ben Reich

David Watts

Dan Samorodnitsky

Mark Fischer

Marc Campasano

Regine Mechulan

Robert Hovden

Disclaimer: Some or all of these names may pertain to imaginary/non human people. We're not sure which ones.

Table of Contents

Or as we like to call it, Organized Chaos



Zombie Aid	4
Hint of Optimism	5
Lunatic's Love Connection	6
Fool Proof Ways to Ensure your Roommate Becomes Your Best Friend....	8
Billy Joel and B.o.B. Visit Cornell	10
Disaster Word Search	11
Occupy Cornell Movement	13
Zombie Profiles	14
2011 Ithaca Earthquake	16
Scale for Measuring Disaster	17
Modern History	18
Arm-ourous Disaster	19
Washing Machines Eat Socks	20
10 Common Things to Go Wrong at an Airport	21
Wardrobe Malfunction Leads to Body Sacks	22
Cornell Lunatic Tears Down It's Foundation	25
Virus Downs Lolcats and Reddit	26
The National Small Disasters Association	28
Batman: A Peanut Rendition	29
Who to Blame:	30

The Cornell Lunatic, Cornell University's only humor magazine, is published a finite number of times per year by the Cornell Lunatic, Box #56, WSH, Ithaca, NY, 14853. Requests for advertising, submissions, money, fantasy football advice, fantasy croquet advice, hate mail, love mail, indifferent mail, and any other communications should be sent to the above address. Copyright © 2011 by The Cornell Lunatic, all rights reserved. This magazine is partially funded by the Student Assembly Finance Commission. Nothing in this magazine necessarily reflects any of the opinions, ideas, beliefs, hopes, dreams, or drug-induced hallucinations of the SAFC, CU, the student body, or even our staff, so please calm down. Offended readers take heed, we're only kidding.

ZOMB-AID



Willing to Die for Our Rights ... Again

For years now, your generosity has helped change our world for the better.

That one dollar a month has saved the tigers in Asia.

Your twenty-five cents a day has kept an African child clothed and fed.

But now, we ask you to open up your heart and mind to a cause that is too often tragically overlooked, but no less in need of your support.

Every day, thousands of Living Impaired individuals continue to struggle in this country, barely surviving at or below the poverty line, and their numbers are rising daily. Betrayed by monstrously biased portrayals in the media, a staggering 91% of all citizens who currently identify themselves as Reanimated Americans report experiencing some form of discrimination based solely on their status as Non-Living entities.

Sadly, this anti-Undead sentiment has grown so widespread, many have been forced to conceal their true identities in order to find even simple day labor, as demand for governmentally supplemented employment in the fry cook and commercial bus driving industry has grown too large to fulfill the need.

This is not purely a domestic crisis, however.

As worldwide testing of viral and atomic weaponry increases, so too do we see an increase in the number of infected. In many developing nations, a lack of proper medical facilities and education on the subject combine to breed strong Pro-Living sentiments, which have resulted in the internment of the Undead population in many countries, as well as the slaughter of untold innocents.

There is hope, however.

Through your donations, you will be helping aid not just domestic education and awareness efforts, but also our Braces for the Broken campaign, which aims to provide replacement limbs to those who have been victims of Pro-Living related violence, or have simply succumb to the stresses of time.

So please, just because they are the unholy spawn of failed attempts to play God does not mean that their moans for equality deserve to fall on deaf ears.

To find out more information about the Zomb-aid foundation, or if you wish to offer your support and assistance to the cause, please visit the center nearest you, or give us a call at the number provided by your local Genetic and Viral Research facility.

A Hint of Optimism ...

With all of these terrible disasters occurring worldwide, with many more to come, sometimes you have to step back and look at the positives that come from such calamities.

In the wake of Hurricane Irene's massive flooding, Bob's Rainboot Emporium completely sold out its stock for the next ten years. During our interview with him, he stated that he was utilizing his sudden heavy climb in profits to move to a more elevated area that "doesn't suck as much."

As the 2012 disaster looms, racists nationwide take solace in the fact that their claim "that we would cause the end of the world by electing a colored man as president" will be proven true.

As Occupy Wall Street protests grow, criminals nationwide can rejoice at the opportunity to loot freely since police are preoccupied dealing with peaceful protests against dubiously legal business practices.

As the 2012 disaster looms, minority activists nationwide take solace in the fact that a colored man became president before the end of the world.

After the BP oil spill, mermaids oceanwide rejoiced that their secret underwater cars would never need oil changes again.

With the passing of Steve Jobs, millions of Americans had the opportunity to feel clever by making jokes about his death and Apple products.

With the news that a particle can travel faster than the speed of light, thus crumbling modern physics laws as we know them, crazy scientists can now hold fast to the idea that they may one day be able to ride a Tyrannosaurus Rex.

After the earthquake in Virginia hit, the Washington Monument was shaken so much that it now tilts several degrees to the right. Upon hearing this news, Republicans and other conservatives nationwide rejoiced.

In the wake of the tsunami in Japan, millions of pet fish enjoyed freedom and the joy of being reunited with their brethren.

As Occupy Wall Street protests grow, corporate executives now have reason to laugh mirthfully from their penthouses while looking down on the masses.

The Lunatic's

Love Connection

(Holding up picture of mother) Yesss, you'll do just fine. Juuust fine.

If you were a mail-order bride, I'd get two day shipping. Obviously as long as I still had that free Amazon Prime thing.

(Skyping with mother on iPhone) Look mom, my new girlfriend!

(Immediately after getting a number from a girl) President Scoooooore-ton!

(Anything that involves showing her pictures of what your kids together would look like)

So when do we get to perform the coitus?!

When I look at you, I feel a stirring in my loins...Oh nevermind, that's the crabs.

(Talking to picture of father) See! I told you real girls would talk to me!

Hey baby, you come here often? Cause I do... I sneak in at night and just go to town all over the chairs and tables.

This bar is lame, wanna blow this popsicle stand like a cheap male escort?

Disas-trous Pick-Up Lines

Our time together is like my power cable in Starbucks... Too short.

You....look way worse in real life than on Facebook.

They say that the rate of failure for birth control pills is 1%...well I want to Occupy your Wall Street cause I'm the other 99%.

You know the move, "Helicopter Dick"? I invented it.

On Men Trying to Keep Their Penis Out of Things

Perhaps today's most widespread disaster
is men sticking their penis into things.
You shout "Stop!" but they only pump faster,
they know not of the horror their dick brings.
Why can't they keep their schlongs and choppers out
of windows, ex's and that rando's mouth?
Their bananas, they'd stick without a doubt
into whatever comes their way, due south.
They think their weenie is supple yet strong,
able and willing to fill any hole.
They really don't care if it's right or wrong
that they cannot control their own spring roll.

We all know men have really big sex drives
but please, at times, let your groin ferrets take five.

Song of a Lonely Heart

Hey there girl are you a quarter on the floor?
Cause I'd like to pick you up
Pick you up, put you in my pocket and take you home.

Yeah girl you're like my asthma
You take my breath away
And leave me gasping for air
It just isn't fair
(Inhaler? I hardly know her!)

Were you in the Revolutionary War?
Cause I seem to remember...
One if by land, two if by sea
And perfect ten if by you

I Paul Revere you,
If you shook my hand
I wouldn't be Washing it a ton

You're like a stop sign,
But I only come to a rolling stop
To glance at you and continue on
Cause stopping and staring would be creepy

A stop sign of seduction
A yield sign of yearning

Baby, you give me a traffic jam...
Of the heart

This is the pickup song
Where I try to melt your heart
Is it working yet?

How about now?

LORD OF THE RIDICULOUS

Me: So what are your hobbies?

Her: Hobbies? Hobbits?
Precious hobbies!

Me: Right then, I must be leaving,
excuse me.

Her: Ok well when you're free, give
me a ring?

Me: Suuuuuuuuure (Leaves)

TEA OR COFFEE?

Her: Ok so I'm kinda a big Starbucks
fan, I just fucking love lattes
and fraps and mmmmm.

Me: Oh? I'm more of a tea drinker
myself.

Her: Well hey! We already have
something in common!

Me: Tea fan too, huh?

Her: What? No no, those silly
bobillies at SAE and Alpha
Delt gave me the nickname
Teabagging Trish in college!

Me: Uhhh but that was just in
college right?

Her: Yup! Now everyone on the porn
sets just calls me Tentacle-
Rape Trish! Nicknames are fun!

Me: Check please.

THE HORNY

TIME TRAVELER

Me: Hey there, with that beauty
and those brains you're quite
the Cleo-catch-ra!

Her: Guards!

Me: So that's a denile then?

Her: I have snakes in my bag.

Me: And this is me leaving.

Scientific Seduction

Me: Damn girl, you are
hot! You're practically
glowing! What's yo name?

Her: Marie Curie

Me: Ooooooh.

Fool Proof Ways to Ensure Your Roommate Becomes Your Best Friend

You've submitted the application. You've received the letter of acceptance. You've spent hours researching meal plans and housing options (because let's face it, when not taking classes at Cornell, anything you do seems to leave you with too much free time). Chances are that you have no idea with what type of unfortunate soul you will be sleeping, studying, or attempting not to cross paths the rest of the school year. The nervousness sets in as you arrive on campus and await your first encounter with this soul and search your brain for any and every way in which you might be able to provide a good impression. Not to worry, we have your back, yes really, we have provided a Cornell exclusive list of ways to ensure your roommate become best friends by the end of the first semester.

The minute you see your roommate, blatantly check him/her out and loudly state "I could work with that."

Scream "Cornell, GO BIG RED" anytime your roommate begins to talk about something related to the school.

Every time your roommate's phone/computer makes any sound, mimic that sound on the top of your lungs.

Keep a prescription bottle filled with "tic tacs" next to your bed, take one before sleep every night claiming that you got addicted to Roofies a long time ago and now can't fall asleep without them. If your roommate has friends over, constantly attempt to slip a "tic tac" into the friend's drink.

8

Set your alarm to ring loudly every 20 minutes of the night claiming that you are "afraid to die upon entering REM sleep." Wear ear plugs to bed.

Constantly ask your roommate "Want to know something really funny that happen? Oh actually never mind, I can't tell you."

Wake up 5 minutes before your roommate's alarm goes off and blankly stare at them until they wake up and see you staring. Do not smile or move.



Make friends with all of the people your roommate introduces you to and constantly attempt to introduce your roommate back to the people who you met through him/ her.

When you first meet him/her, hug them for an uncomfortably long period of time while moaning his/her name.

Laugh randomly and at inappropriate times.

Spend a night collecting the spiders on the bridge. Place the container in the middle of the room claiming that you are allowed to have anything that fits in a tank. The next morning replace the container with an empty open one. Make sure your roommate wakes up to you frantically searching for your spiders all through the room.

If you are assigned Balch Hall, dress up like a guy on move in day, creepily look at everyone on your floor and say "This will be a fun semester".

Always talk about all your accomplishments from elementary school. i.e. "This one day in kindergarten, I actually drew a dragon and won the school drawing contest, I was probably the best artist in the whole school, they thought I'd be the next Picasso."

Sexile your roommate often, and when you do so, sit alone in your room watching TV.



Friend your roommate's parents on Facebook. Take daily pictures of his/her side of the room and post them on their parents' wall. Bonus: Get random people of the opposite sex to lie in your roommate's bed. Take pictures of the stranger and post them on Facebook.

Whenever your roommate takes off an article of clothing, pick it up and loudly sniff it. (See comment above)

Make a dating advertisement for your roommate and print thousands of quartercards including his/her phone number, picture and net ID; hand them out at ho plaza.

Get giant poster printouts of your roommate's face and hang them up next to your bed before your roommate moves in. (Works best if the enlargement is at least 4X life size.)

Constantly one-up anything your roommate says.

Invite random people over who do not go to Cornell to take naps in your roommate's bed.

Whenever you eat in your room, loudly moan every time you have a bite.

Constantly talk about how you hate mainstream music and listen to only indie. Blast ke\$ha and Katy Perry constantly.

Ask them what they are planning to apply for or do outside of academics. Apply for all the same things.

Every time your roommate is about to walk into the room, loudly whisper "shit, she's/he's coming".

Advertise for free stuff around campus with your roommate's net id as the contact.

Go to club day; sign your roommate up for every club.



Photoshop your roommate's face into nude pornographic pictures, preferably of someone of the opposite sex. Make it your home screen. Leave your computer open.

Take credit for anything your roommate does.

Put up your roommate's items on craigslist.com for a cheap price; include your roommate's phone number for the contact.



Constantly draw pictures of grotesque weapons and hang them above your roommate's bed. If he/she asks, don't say anything just stare.

Call your friends from home in the middle of the night while your roommate is asleep. Blame it on the "time difference".

Anytime your roommate comes home, jump on him/her and scream "I've missed you." (If you are in a triple or quad, this is most affective when synchronized with your other roommate)

Every morning an hour before your roommate's alarm should go off, jump into his/her bed and take a picture with him/her. Print out every picture and hang them all above your bed.

Constantly lay and stare at them smiling.

Bring a pet rock. Constantly freak out at your roommate because they didn't walk it. Bonus: Dress the Ezra Cornell and Andrew White statues in their clothes. Say that they looked like they were cold.

I Don't Always Go to Ithaca, But When I do, I don't Pay For Shit

Upon Billy Joel's arrival in Ithaca, The Lunatic sat down with Mr. Joel to ask him his thoughts on dining out in a classy establishment like Level B.

(What follows is a transcript of his response to our open-ended question)

Normally, when I walk into a restaurant, or bar, or pub, or anywhere they might expect money in exchange for food, I begin by waiting to be seated. Although my music graces the soundtracks of perhaps dozens if not hundreds of very famous Movies and TV shows, I recognize in the fact that I am not superior to other human beings.

“Particularly in today’s tough economic climate, a world famous musician with the coffers of a medieval warlord ought to make things easier for others, especially if they bring him expensive, imported alcoholic drinks for hours on end.”

My 33 Top 40 hits, all written by me, do not necessarily mean that I should be given priority service in a popular venue. However, should they chose to give me priority service, I would feel most obligated to pay a handsome tip, especially if my party is to occupy part of said venue for the better part of two hours.

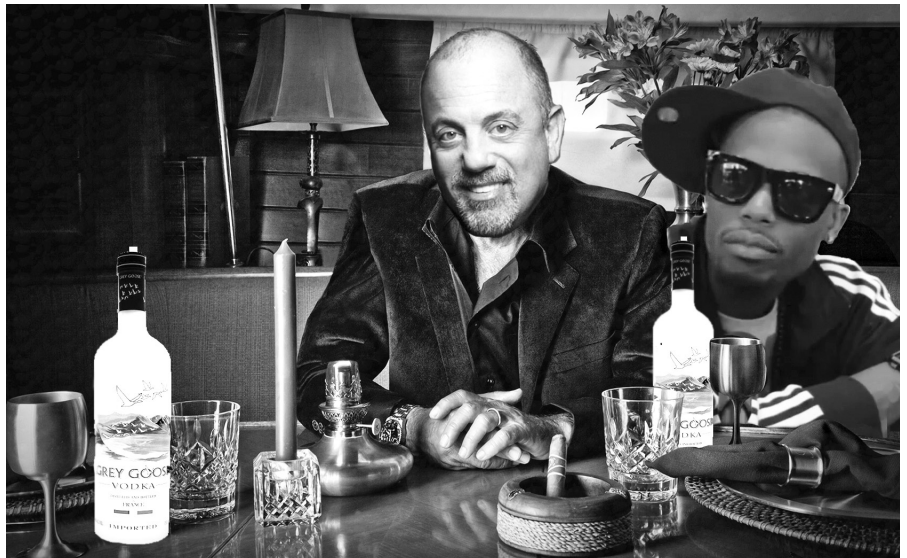

Although many of my fans, who cross both generations and continents and have been listening to my music for longer than the last 20 months, often force free goods and services upon me, I always offer to pay.

Like most human beings, I assume when people give me things, they expect something in return. I do not operate under the assumption that everything will be handed to me on a silver platter; if I did surely someone with a different notion of capitalism may expect payment from me, and in the ensuing misunderstanding I would come off as a total douche bag.

Finally, if due to a wacky misunderstanding, I were to leave this hypothetical venue without paying for twenty-seven months worth of a Chinese sweatshop worker's salary, and a waiter were to literally chase me out the door to inform me of my debt to his venue, I would most likely apologize and pay my tab. Since I am the sixth best selling recording artist in the history of the United States, odds are there is enough money in my bank account to pay up, and no bar tab is worth more than my professional reputation for writing and performing music with my own talents on a variety of instruments without the aid of a computer that does my job for me.

Top Things You Plan To Do In Your Last 5 Minutes Before Apocalypse

- Thai food
- Not have sex - moral high ground!
- Have sex - as many times as you physically can
- Eat someone, limited time so work with what you got
- Prank phone call
- Make deal with all gods and deities -> bidding war
- Lactose intolerant will drink whole milk
- Drugs - take them ALL

Top Things You Wind Up Doing In Your Last 5 Minutes Before Apocalypse

- Check Twitter and Facebook
- Cry
- Masturbate in corner (tear lubrication?)
- Cry again
- Hook up with step sibling (Call me daddy)

Disaster Word Search

A	P	L	E	G	U	A	Y	Z	U	K	N
A	E	R	A	T	H	Q	A	U	K	E	I
E	D	P	C	S	O	O	N	F	A	G	T
D	R	A	N	N	E	T	S	C	S	M	A
Y	I	O	A	I	Z	G	R	H	F	T	R
S	Z	G	L	M	X	I	N	L	B	Y	N
E	Z	E	V	A	R	T	J	I	X	W	O
A	L	D	A	U	T	H	U	O	G	R	D
R	A	L	H	A	E	U	H	F	M	I	O
H	B	O	W	R	M	I	H	C	N	E	O
C	E	O	W	I	L	D	E	F	I	R	K
A	T	F	A	N	I	M	E	S	C	L	T

- 1) Seismic activity in the Earth's crust
- 2) Another name for a twister
- 3) An overflow of water
- 4) A scarcity of rain which effects crop growth
- 5) A violent tropical storm
- 6) A _____ quickly spreads as it burns through forests
- 7) A large and destructive wave
- 8) A violent snow storm
- 9) An _____ is when a large mass of snow detaches from a mountain slope and slides downward
- 10) An epidemic disease that causes high mortality
- 11) Extreme and general scarcity of food
- 12) A dyslexic person creating a word _____

Truck Weigh Stations

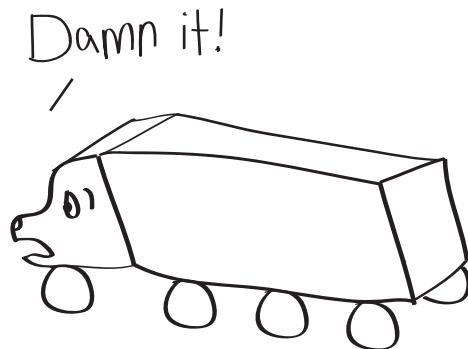
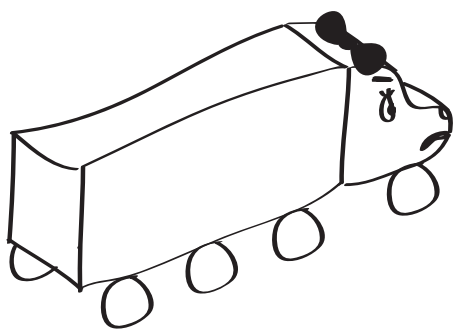
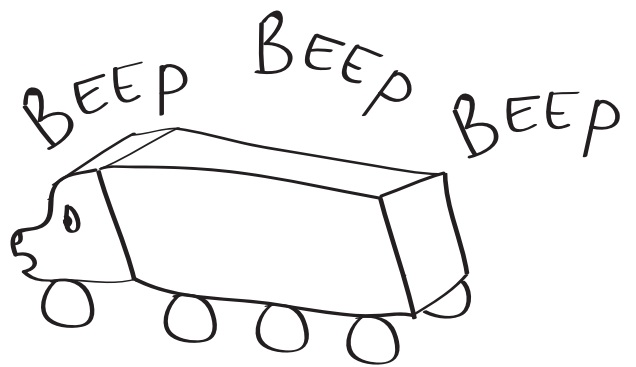
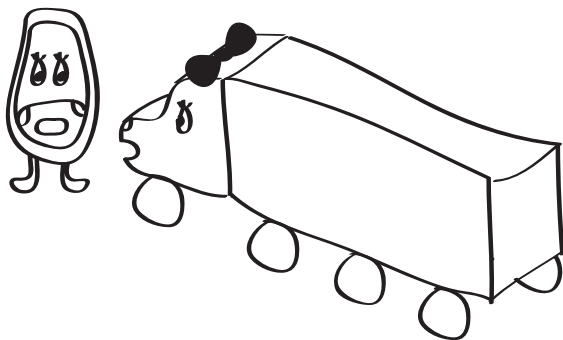
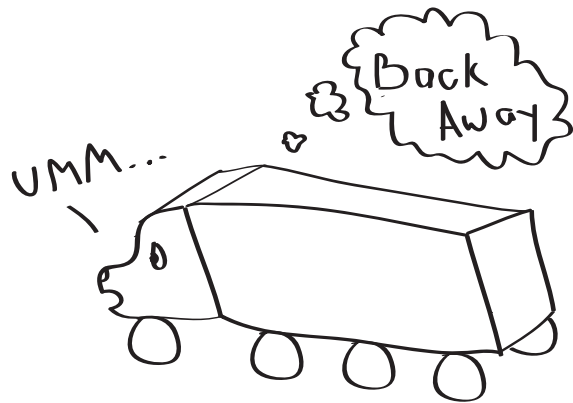
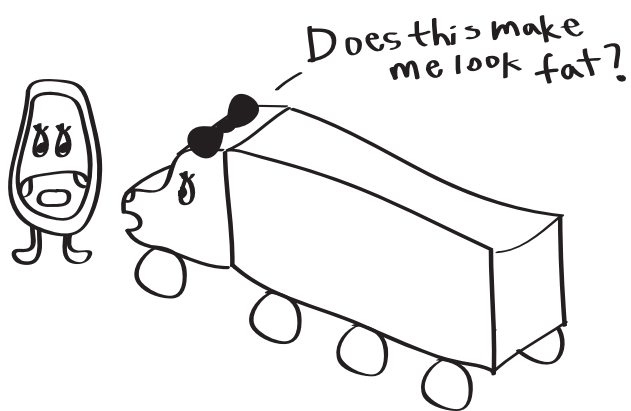

Occupy Cornell Movement Searches for Change

Angsty Youthful Entitlement Comes Home

Dozens of Cornellians swarmed the Ag Quad last week, holding passive aggressive signs which protested economic conditions which they will never have any control over. They rallied around the cry of “We are the 99%”, as they seem to mistakenly believe that even people in the top 2% of the income bracket will rise up against the 1%, because fuck those guys.

In response to this display, Cornell AEM students walked around the quad with “We Are The 1%” signs while smirking. In response to THIS display, Cornell engineering students walked around the quad with “We Are The 3.1415%” signs while also smirking, slightly more so.

Aside from the hippies, the 99% rally was primarily attended by Arts and Sciences students who realized that they are all passionately studying subjects with no job security or prospects.

Perhaps the most interesting thing about this event, however, is that the hippies came out of the woodwork from all over Ithaca to show up in force for this event. The only shoes seen during this display were worn by the irreverent AEM students. Hemp

clothing and dreadlocks on white males were also disturbingly abundant.

When interviewed, one anonymous Arts student exclaimed “I demand that the government gives me a bail-out!” When

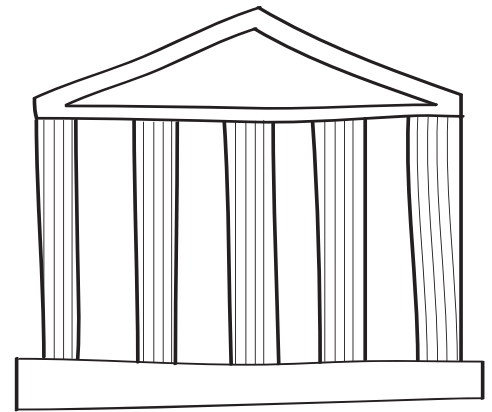

questioned about these obscure demands, the student replied “Wait, you mean the government has never provided bailouts to self-entitled History majors before?” Another angry protester complained that he had taken out a six figure loan to go to the College of Arts and Sciences while living in New York. When asked why he simply didn’t “live within his means” or “go to a fucking state subsidized college at Cornell”, he began foaming at the mouth and the interviewer was forced to flee. Fortunately for this interviewer, people without shoes are much easier to run from.



Zombie Profiles

Find out what kind of undead creature you'll become during the Zombie Apocalypse



Arts and Sciences Zombie



STRENGTHS
Diversity: Gives the zombies a wide angle of ideas and approaches to capture the pray.
Clock Tower: Can use clock tower as defensive and offensive fort. Will allow zombies to find pray and eliminate them.

WEAKNESSES
Indecisiveness: Creates confusion when multiple pray are present. Allows for all pray to escape while the zombie makes up his/her mind.
Stamina: Had the least exercise getting to class before infection, therefore can easily be tired out.

Zombie Engineer



STRENGTHS
Ingenuity: Have the ability to manipulate the environment and thereby capture more pray.
Drive: Most engineers were borderline zombies before being infected therefore starting out as a highly driven zombie.

WEAKNESSES
Sleep: Weakened by the lack of sleep prior to infection; very easily tired out as a result.
Disguise: An engineer is easy to spot allowing the pray adequate time to assess the situation and escape before being captured.

Human Ec. Zombie



STRENGTHS
Disguise: Since most Cornellians don't know of the College of Human Ecology, the attack will be unexpected.
Relations: The connections among zombies will allow for splendid team working skills.

WEAKNESSES
Man Power: Small size of school will limit the spread of the epidemic and limit the size of the attacks arranged by zombies.
Medicine: Time will be wasted studying the disease and finding a cure as opposed to spreading it.

Would you like some salt with that flesh?



Zombies don't do homework, they eat the Professor.



Zombie Architect



STRENGTHS
Coverage: Can build a state of the art lookout fort which will cover all of campus and not allow anyone to escape.
Skill: Practically zombies prior to infection therefore have an easy adjustment.

WEAKNESSES
Time: The time spent building forts will hinder the time spent infecting other students and thereby the speed of the attack.
Seclusion: Zombies tend to only spend time in architecture building which offers little prey.

Zombie Hotelie



STRENGTHS
Connections: Uses connections with other zombies to team up against any prey. Hunting together ensures a high success rate.
Well Trained: Lack of real classes allows for adequate training in the zombie skills.

WEAKNESSES
Attire: Business attire does not allow for optimal movement and therefore hinder the zombie.
Motor Skills: Constant intoxication hinders dexterity and therefore success in efficiently catching the pray.



CALS Zombie



STRENGTHS
Funding: New York State will subsidize zombie attack by sending state zombie funds.
Animal Aide: Can infect animals and plants and build a zombie livestock army to carry out attack.

WEAKNESSES
Location: East Ave. can be flooded to create a moat to spare the Arts and Science students and the Engineers.
Medicine: Attack will be hindered by the time spent in an attempt to cure the infected.

ILR Zombie



STRENGTHS
Funding: New York State will subsidize zombie attack by sending state zombie funds.
Disguise: Lack of recognition will allow zombies to disguise themselves and lure prey.

WEAKNESSES
Humanitarianism: Will be inclined to fight for the right of the pray to live therefore hindering the progress of the zombie invasion.
Size: Limited networking within zombies due to small size of school.

The 2011 Ithaca Earthquake As Seen by an Engineer

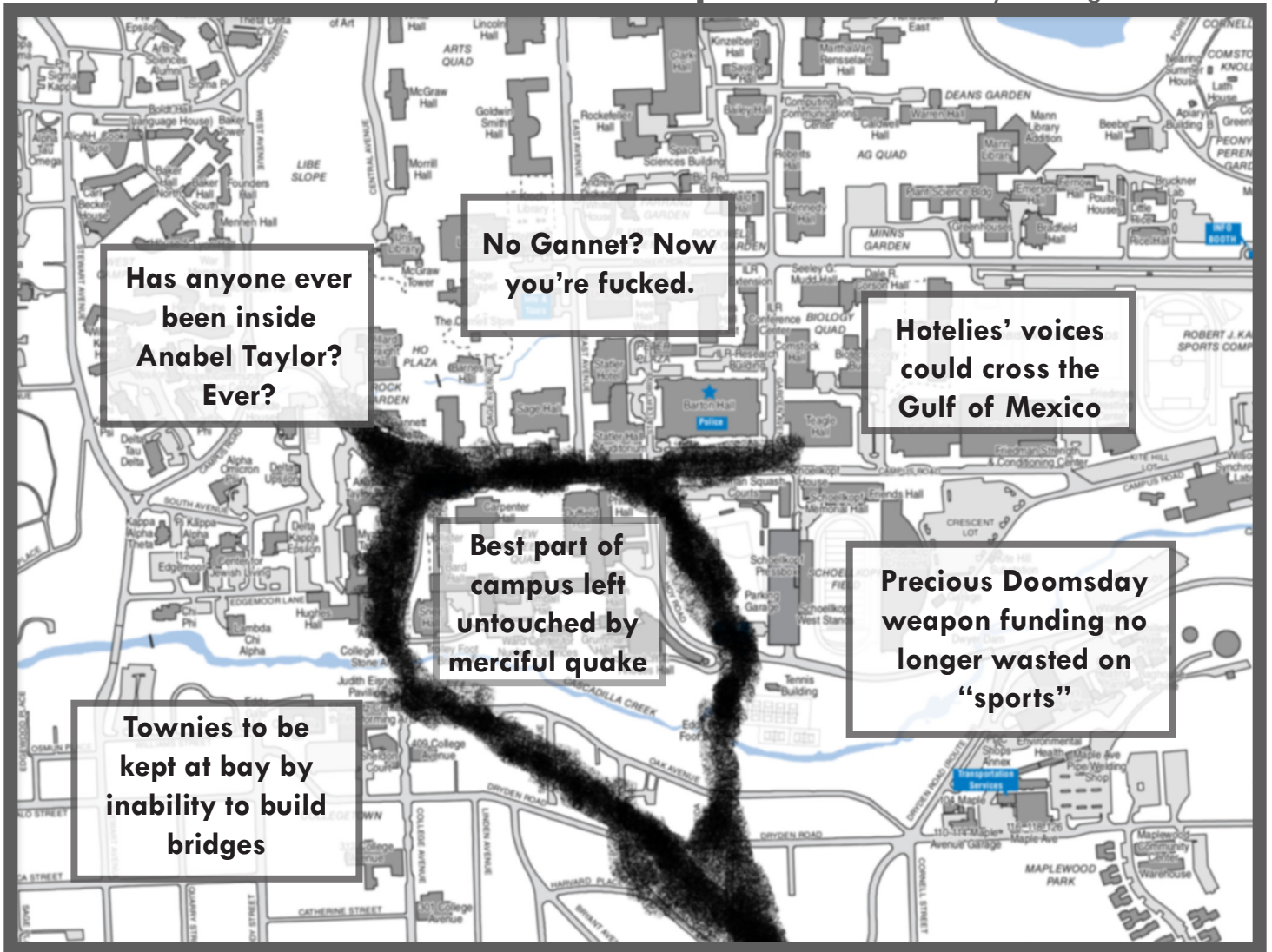

Lunatic Scale for Measuring Disaster

Helping You Help Yourself to Help

0

Your mom flushes your goldfish down the drain. It's okay; it had chlamydia anyway.

1

You bring a hooker back to your room on Saturday night, but it's super messy; so she "trips and falls, breaking her neck." (Remember that IS what happened, right? Besides you have a closet for these types of situations.)

2

3

You missed all of your classes today. You're part of the cool club now, bro.

4

You just found out that you were molested by your babysitter as a child. (Hey, don't fret; it already happened, and it explains why you get turned on by sandwiches.)

5

Someone just sent you hate mail. How thoughtful of them to think of you!

6

Another Twilight movie just popped out of Hollywood's vagina.

7

You "accidentally" kill another hooker, but you don't have enough space in your closet.

8

Sarah Palin runs for the presidency and wins, with her campaign slogan, "Hey! Why Not?"

9

The Porn Apocalypse occurs: porn is removed from the Internet...and life. (Some deep shit.)

10

You're about to have the happiest moment of your life, and then you die getting speared by a bull. (You're probably wondering what type of spearing that is and why you were about to have the happiest moment of your life near a bull...)

Your goldfish gave you chlamydia. THAT WHORE!!

Modern History

Sure we all know George Washington was one swell dude, but how would he fare if he grew up in today's day and age, forced to apply to college just like the rest of us?

If George Washington was applying to college in 2011:

Interviewer: Now as you know, Yale is a very prestigious school where we hold ourselves to very high standards.

George: Yes sir, I know that sir.

I: So you must be aware that every applicant is screened both in person and on the internet.

GW: (Poker face) Uh...

I: And you must then be aware your Facebook profile had very few privacy filters.

GW: (Stammering) Well...uh...

I: And because Yale does not even interview "dummies", you must not be a "dummy". So you must be aware of your privacy settings and therefore intentionally publicized your very sordid affair with one Miss Martha Dandridge. Which then can only mean you intended me to view your status updates, in particular this following one

(clears throat)

At 5:16pm, June 14th 2011 you posted "Damn, that fine Miss Martha, I totally chopped down her cherry tree last night at prom"

GW: (Steadies himself) Sir, I cannot tell a lie. I did indeed write that status.

I: I appreciate your candor George, but we just cannot have miscreants that go around "chopping" down young women's cherry trees!

GW: Well, to be entirely truthful sir, I didn't...I didn't...actually do it to completion.

I: George?

GW: I just needed to look cool for my bros sir! That Thomas, always getting the ladies. It's like his women are slaves for him! I just wanted to be one of the guys!

I: So you decided to do the honorable thing and stop the progress of your First Sexual Continental Congress?

GW: Well that...and the whisky dick.

I: And that concludes the interview!

Arm-orous Disaster:

THE LIFE AND TIMES OF BRIAN'S ARMS

A captivating story from the perspective of an arm who has been neglected for much too long ...



Steady...steady...oh shit, I'm falling asleep. God this guy is heavy, how does he expect me to stay like this while he thrusts? I feel like people should understand how hard it is for me to just lie here like it's nothing, because it's not, people are not light and when they're experiencing pleasure they move a lot. No one stops to think that maybe the key to awesome sex is where I'm placed. PLEASE ASK TO BE ON BOTTOM, JUST USE ME AND GRAB HER AND SWITCH POSITIONS.

Ahhh, the sweet relief of her being on top of him...fuck, now what am I supposed to do with myself? Should I put one arm behind his head, or is that too douche-y looking? Should I reach up and touch her nipples? So now I'm stuck here reaching up, and his head is following me a little, this is starting to hurt me too, (sidenote: sorry for hurting you too back and neck). Okay, I'm just gonna lie by his side, oh shit now he feels weird because he looks a little dead, she must not like this either, he should tell her he likes it so that she can accept where I am right now. I just want to be by his side.

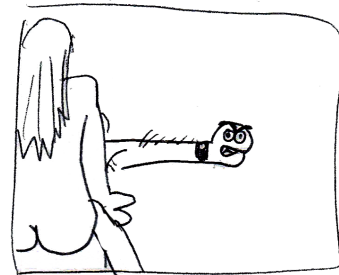

OH YES, reach down and kiss him! Perfect, now I'm just holding onto her back, not tiring at all for me. Backs are sexy.

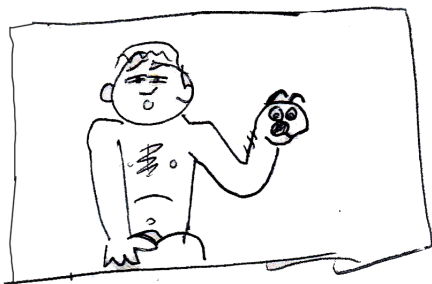

Oh wow, I did not expect to grab her and slide down her, OH NO THIS MEANS I'M USING MY FINGERS NOW. How long am I supposed to keep this up without cramping? Does she like it, I can't tell sometimes, he's for sure starting to get tired. Okay, I think she's good now, I think we can go back to being on top, I feel rested enough to support his weight.

Thrust...thrust. Oh god, I think it's getting faster, he's starting to lean on me more, oh shit, I can't handle this amount of pressure. HOW AM I SUPPOSED TO NOT MOVE OR COLLAPSE?! He knows, he's got to know that I can't do this. Come on. Come on. Just let her be on top for the finish. Just give it to her. FUUUUUUCCCKKKK. Why am I moving in so many directions? WHERE AM I GOING? He should have known that I would wind up flailing around like a muppet when he came. She probably doesn't think this is sexy, maybe he could say he sneezed and couldn't control me? God this is a disaster; they for sure will not be doing this again together. I should apologize. Maybe next time he's flying solo I won't cramp as much, yep that's probably thanks enough.



Washing Machines Eat Socks

Washington, D.C.— Government officials, joined by representatives of Maytag and other reputable washing machine companies, spoke to the media yesterday about the recent sock shortage emergency.

The nation has been reeling from this crisis, caused when every washing machine and dryer in the country suddenly experienced a systems malfunction that resulted in the subsequent devouring of all socks placed in said machines. The resulting serious shortage of ambulatory apparel has caused widespread panic and prompted widespread consternation and frustration across the nation. Mobs of consumers rushed

to malls all over the United States shortly after the first socks began to disappear, soon wiping out the laughably inadequate supply available, leaving millions sockless. Volunteers have been working around the clock to provide short-term substitutes such as extra-large gloves and golf club headcovers to tide people over until the problem can be solved, but the outcome looks bleak. It is estimated that at least 150,000 have died from hypothermia of the lower extremities. "I must ask that people remain calm. This may test the moral fiber of our country, but we have been through hell before as a country and by God we will get through this, cold feet or no cold feet!" exhorted President Barack Obama, in an emergency address to the nation.

Technicians for the industry have been working around the clock to figure out how to fix the problem. Scientists believe that the cause is partially known, raising the hopes of many. "It has

always been accepted as a fact of life that every now and then, a sock would be lost to the laundry machine, and we

"Studies have shown that the violent motion of the laundry machine causes missing socks to escape into an alternate dimension through a tiny worm-hole and we think the recent crisis is merely an escalation of this."

J. Parker Scott

accepted that. But this is truly unprecedented.

"The question now is to figure out what ripped open the fabric of spacetime and created this tangled network of worm-holes massive enough to affect every machine in the entire country."

Some leading physicists have theorized that it might be possible to travel into this alternate dimension and retrieve the socks, especially given the recent revelations regarding neutrinos and the speed of light. Until then, the facial tissue business continues to grow exponentially with its sudden monopoly of the adolescent male demographic.



10 Common Things to Go Wrong at the Airport and on Planes



The airport's busy and the line for security is unbelievably long, so you have to wait forever.

You forgot to take your lube out of your bag when you packed, so the TSA officer empties out your bag and awkwardly pulls the lube out in front of everyone.

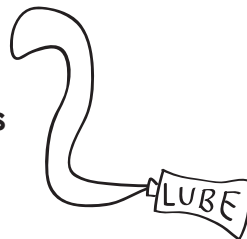

You get randomly selected for a strip search, and get really turned on, which weirds you out.



You forget your boarding pass in the toilet stall. You wait for the next woman to come out so you can get it. She brings it out for you – covered in piss.

You leave your bag unattended at the gate while you go to get some food, and it gets “neutralized” by the bomb squad.



A man on your flight uses his Kindle during takeoff, despite warnings to turn off all electronic devices and the plane crashes. Just kidding! That's impossible.

Your flight is a redeye and there's a baby who cries the whole time.

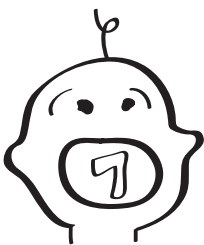

You get seated between two tremendously fat women. They keep asking you vaguely really personal questions like, “Do you ever fantasize about grapefruit or melons?” and won't let you out to go to the bathroom until you answer.

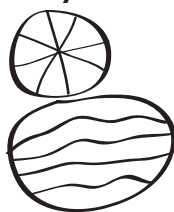

The tremendously fat women both brought truly fetid rotten fish to eat for dinner. Whenever they open their mouths, it smells like the ocean is vomiting on you.

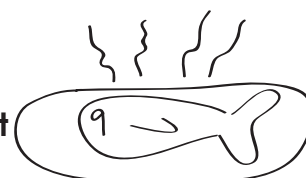

You read your Kindle during landing and it runs out of battery before you can finish the book you're reading. Also, the plane is going to crash. Actually this time. Everyone dies.

Enjoy Your Flight!

Minor Wardrobe Malfunction Leads to Campus-Wide Institution of Ungainly Body Sacks In Lieu of Traditional Clothing

CORNELL, NY- In the wake of the infamous “side boob” incident at last month’s Women in Entertainment awards, campus officials on the newly formed Attire and Decorum Board have pushed a controversial new policy aimed at reducing accidental clothing mishaps through the use of cumbersome body sacks. The sacks in question, first developed for use in Japan, have been shown to increase student productivity by eliminating all facets of individuality, while severely decreasing both mobility and sex appeal. Student response has been largely divided, garnering support from more conservative crowds, but drawing mass criticism from sluts and men alike. With Halloween fast approaching, widespread protests are expected from students championing their rights to wear trappy, revealing costumes, but efforts are expected to be impeded by the overall lack of arm holes in the suits themselves.



Fashion Disasters: Professor Edition

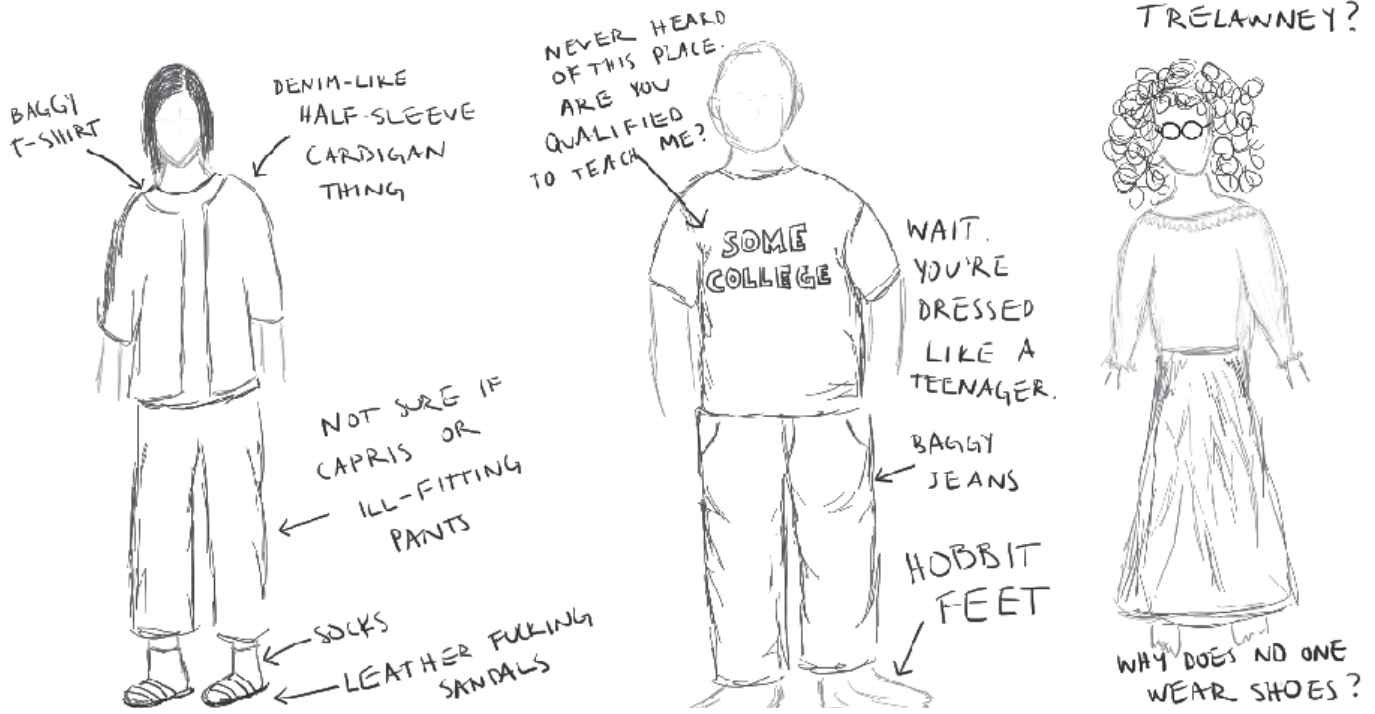



S N A P

*Marshmallow
Sunken Ships
and Crunchy
Dead Pirates*

K R A C K E N



P O P





Apple's latest invention ...

The iNuch!

Comes Pre-Castrated so that he can perform all of your servant needs without all of that pesky testosterone.

Buy One Today!

Donate
Today!



Undead ...

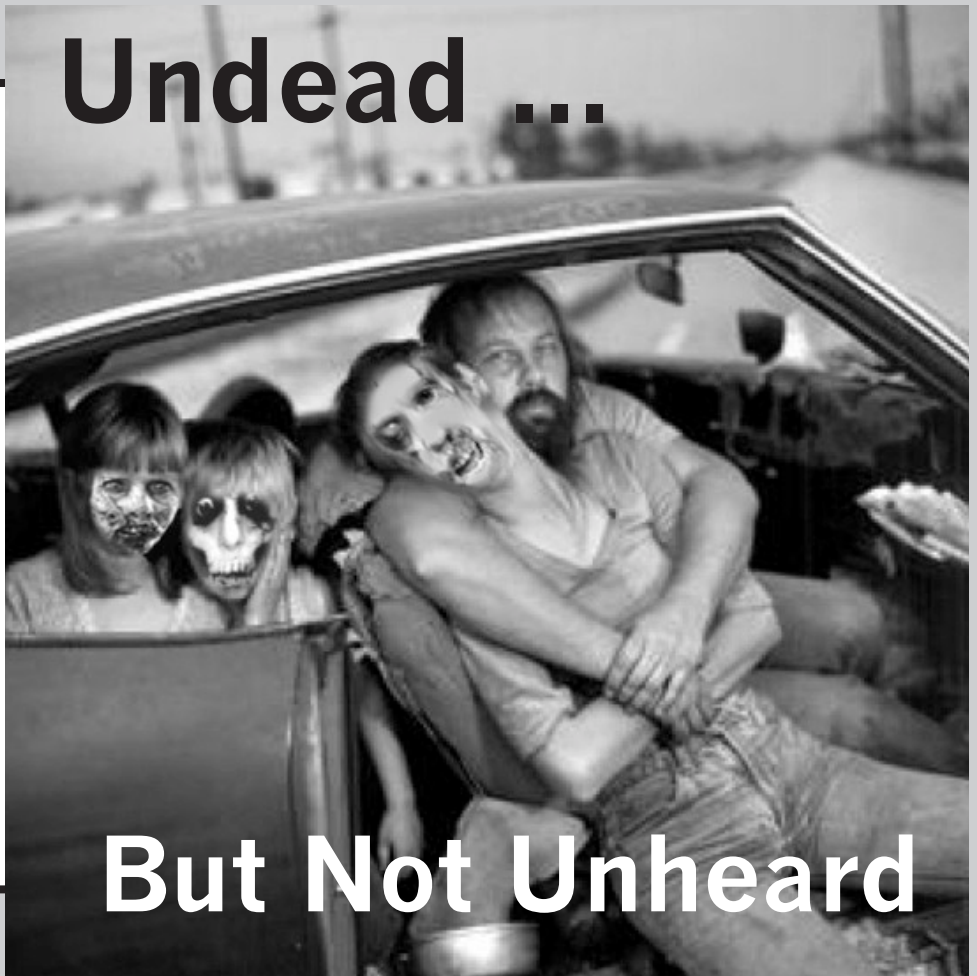

But Not Unheard

Cornell Lunatic Tears Down Its Foundations

The most recent disaster that occurred in this nation hit very close to home, actually affecting the Cornell Campus in a marginal way, when the Cornell Lunatic shattered its thirty year history and firm foundation by almost being funny this semester. Students campus wide angrily protested these changes. As one anonymous junior complained, "I almost feel guilty for using these new issues as toilet paper now."

The drastic change came as a result of the controversial decision to elect a new editor-in-chief last spring. When interviewed, the aghast editor-in-chief Elliot Mandel said "I just don't know what

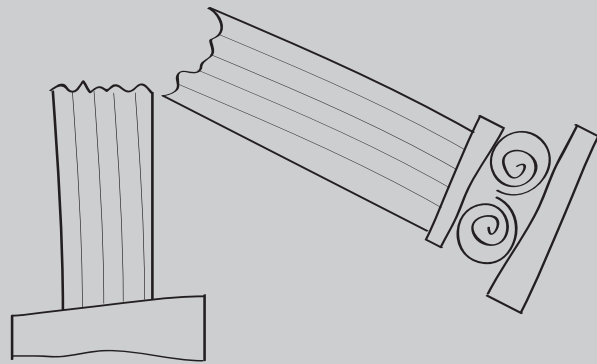

happened. I adhered to every rule in the book, but somehow we still managed to actually have a few halfway decent jokes in this issue. Quality control is becoming a huge problem.

I would like to apologize on behalf of our entire organization." While contrite, the fact still remains that Mandel has torn down thirty years of history and tradition with this past issue. The charter for the Cornell Lunatic clearly states "We shall do our utmost best to make corny jokes that will elicit, at best, a mild "Heh" from audiences." This semester's Lunatic, however, actually has threatened to elicit a sarcastic "Haha", even a smile in some cases. The Lunatic Alumni board is currently debating judicial action against him for his offenses towards the organization.

Virus Downs Lolcats and Reddit:

Palo Alto, California—Relief technicians struggled through the night this Thursday to incapacitate a powerful virus that spread through the Internet, destroying the servers of popular entertainment sites Reddit and Lolcats. “After thirty six hours of desperate coding and photo-shopping we are relieved to declare that we have restored basic Lolcat and Reddit service.

“We pray that this nightmare is over.” Said Marcus Snee, the tech team’s spokesman, referring to the myriad of boredom based casualties of the Internet catastrophe. Millions, dependent on both these sites for a steady supply of inane and shallow humor were suddenly cut off as the “LOLWHAT” virus did its fateful damage. FEMA estimates that roughly five million people were killed in automobile accidents as frequenters of Reddit took to the road in search of things to laugh at. Lacking the attention span to drive safely, their deaths were tragically inevitable. A further million died in attempts to perform the decades of maintenance on their homes, deferred since they discovered both sites.

Another three million realized their waning health and either suffered fatal heart attacks from a simple lack of fitness or caught fire while trying to make real food. Fanatics of Lolcats in the hundreds of thousands swarmed to local zoos and were gored by lions and tigers as they attempted to place captions on them, or were arrested invading homes to do the same to domestic cats.

Another small group were rushed to hospitals with disturbing boredom symptoms. Emergency room doctor Wynona Paulson reports “Masses of people were brought in with extreme brain death symptoms. After a few hours of scratching our heads and speaking with every neurologist we could find we concluded that Lolcats and Reddit readers become so mentally dependent on these sites that the sectors taking input from elsewhere atrophy and die.

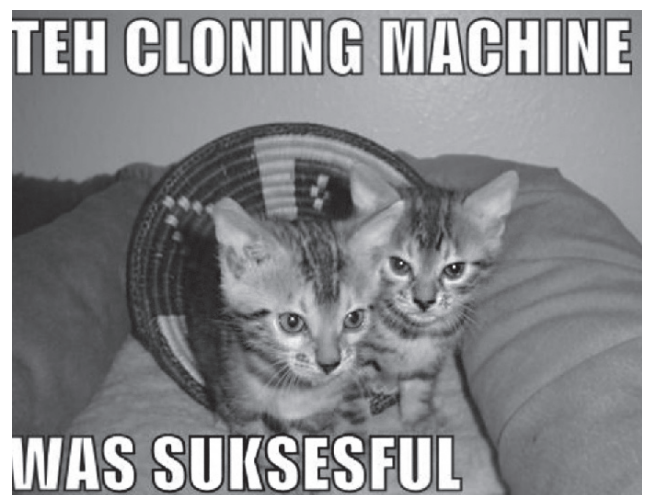

When the virus struck, the last remaining live sector began to starve. Within minutes they became hopeless vegetables. So arguably nothing has changed.” The nation is restructuring in response to tragedy. While the technology sector plans to simply better insure the flow of user written jokes and memes, President Obama has taken a more adversarial approach. “My fellow Americans.

Boredom Related Death Toll Recorded in Millions

Um” Said Obama. “ The horror of the past day and a half has opened my eyes to the danger that internet media presents. By the end of this week I will close my Youtube channel, my Facebook account, and force the shutdown of Moveon.org, with the hope that we can get the hopeless Obama fanatics off the internet before they’re too brain-dead to vote.”

The first lady put it more bluntly. In an audience held in her White House boxing ring she told a battered and bleeding internet correspondent to “stop being fucking retarded.” Kicking

him in the head again for emphasis. America would do well to listen, but not to re-tweet.

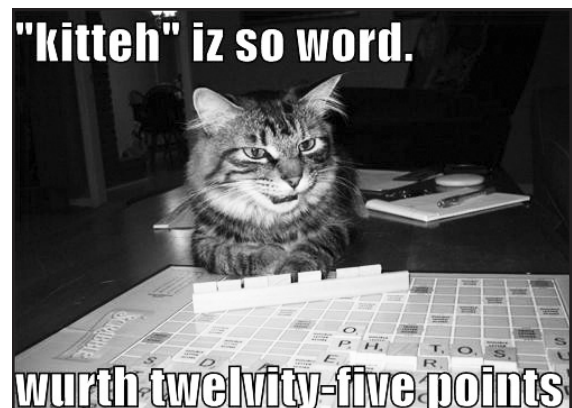

**STELLA TAKES YOUR
PLEASURE
SERIOUSLY**

**THE
BEST COCKTAILS
IN ITHACA**

**WHISK(E)Y TASTINGS
every Tuesday, 9pm, \$16**

SPECIALS	EVERY SECOND IS HALF OFF:
SUNDAYS	DRAFT BEER
MONDAYS	WHISK(E)Y
TUESDAYS	MENU COCKTAILS
WEDNESDAYS	WINE

FULL DINNER MENU UNTIL 11PM, OPEN UNTIL 1AM · WWW.STELLASITHACA.COM · 607/277.1490

The National Small Disasters Association

Bringing small disasters to your attention since 1931

In recent times it seems as though the huge national conglomerate natural disasters have been rudely stealing the spotlight from small disasters nationwide. This article is dedicated by the National Small Disasters Association to helping those small disasters flourish and receive the recognition they deserve, especially during these tough economic times.

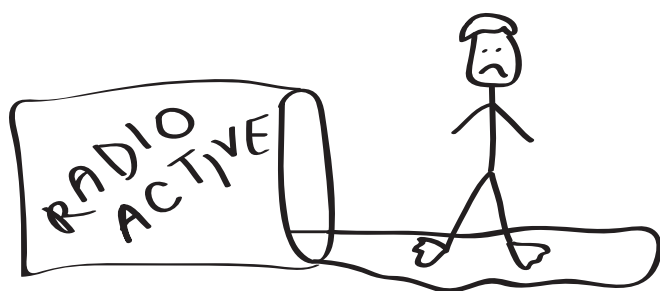

Just the other week, for instance, a chemical spill in Wyoming caused a little boy's feet to become webbed. This disaster was completely upstaged and robbed of its appreciation and recognition by that big fame whore known as Hurricane Irene. With your help, however, we can help small disasters like these reach their full potential. Donate money now to encourage more factories to irresponsibly handle their hazardous chemical waste. Together, we can achieve something truly great by allowing minor chemical spills to

once again receive the attention they deserve.

Small disasters all over the nation have been suffering similar fates. In Virginia, a man drove his truck into a molasses processing plant, triggering a massive, delicious flood of molasses to head towards the hamlet of Worthington-shiretown. Scientists estimate that with the spills current flow of 1 m per week, the town could be engulfed in less than 30 years! However, while this was originally slated to make headlines all through Virginia, that random bitch of an earthquake happened shortly before printing time, reducing the molasses article to nothing but a picture on page 24. Page 24, I ask you! Do you want other disasters to meet similar fates? I think not. I implore you, donate to the National Small Disasters Association today to help these unfortunate disasters receive the attention and nurturing that they deserve.

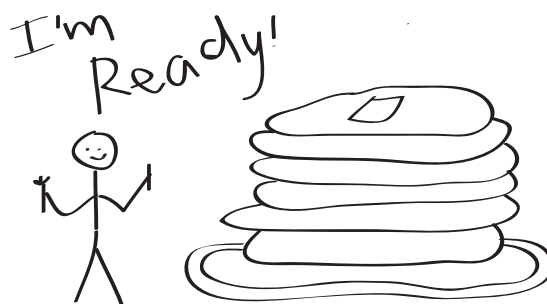

Scarecromeo

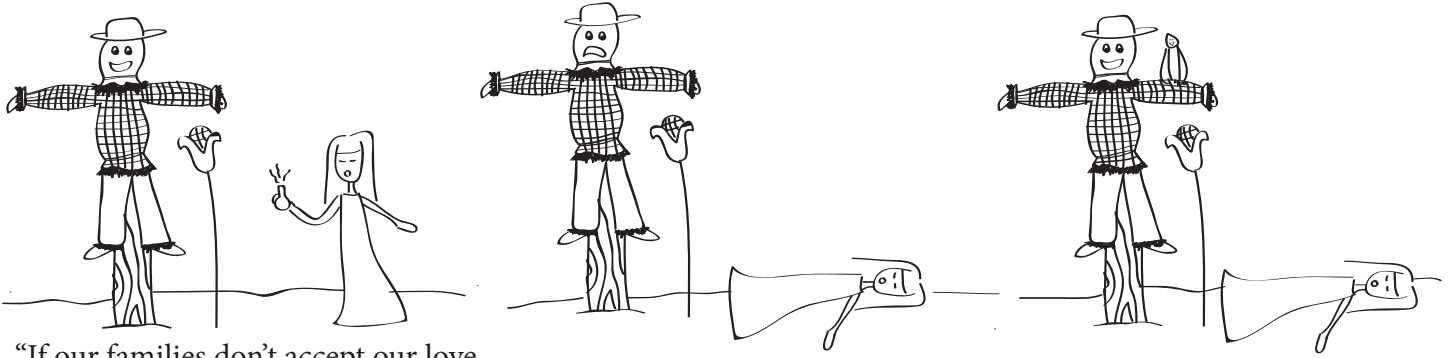

“If our families don’t accept our love, then we’ll be together after death.”

In light of a stronger push towards alternative energy, some TV shows are making tweaks to seem greener.

Presenting:

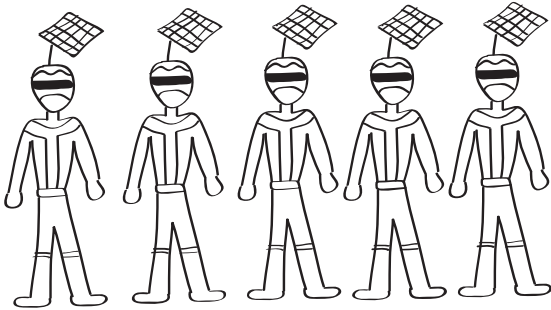

SOLAR POWER RANGERS



Dora the Low-Carbon Footprint Explorer

“Whenever I go to a coffee shop, I like to sit down and glare at someone until they get freaked out and leave.”

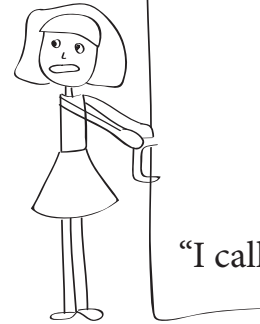
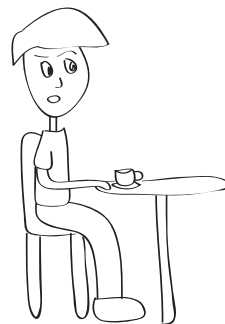

“I call it Stare-Bucks.”

When literary characters play kid games ...

Where’s Dr. Jekyll?

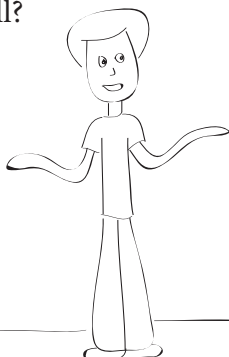

I think he’s still hyding.



BATMAN



BATMAN



ROBIN



BATGIRL



COMMISSIONER GORDON



TWO-FACE



THE PENGUIN



CATWOMAN

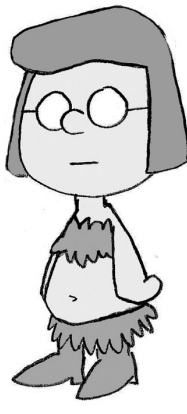

POISON IVY



RA'S AL GHUL



THE JOKER HARLEY QUINN



Blame Page

Zombie Aid: **Aaron Stolicker**

Hint of Optimism: **William Kurinkas**

Lunatic's Love Connection: **Elliot Mandel**

On Men Trying to Keep Their Penis Out of Things: **Emily Choi**

Fool Proof Ways to Ensure your Roommate Becomes Your Best Friend: **Iryna Ivasyk**

Billy Joel and B.o.B. Visit Cornell: **Thomas Pagani**

Disaster Word Search: **Maggie Fleming**

Occupy Cornell Movement: **William Kurinkas**

Zombie Profiles: **Iryna Ivasyk**

2011 Ithaca Earthquake: **Thomas Pagani**

Scale for Measuring Disaster: **Gavin Acres**

Modern History: **Elliot Mandel**

Arm-ourous Disaster: **Leela Chantrelle / John Flanagan**

Washing Machines Eat Socks: **Chris Boyer**

10 Common Things to Go Wrong at an Airport: **Daniel Lewis**

Wardrobe Malfunction Leads to Body Sacks: **Thora Bjorndottir**

Cornell Lunatic Tears Down It's Foundation: **William Kurinkas**

Virus Downs Lolcats and Reddit: **David Clark**

The National Small Disasters Association: **William Kurinkas**

Random Cartoons: **Elliot Mandel / Elizabeth Parcher**

Batman: A Peanut Rendition: **John Flanagan**



Join The Lunatic

**Write for us and you'll have boys and girls
blowing up your phones, phones.
In a good way of course.**

More exciting than the sinking of the Lusitania!

More fun than global warming!

**More captivating than a steamy,
short-lived Trans-Atlantic Cruise.**

**Now a nation-wide distributor of Hindenburgers.
It's an explosion of flavor!**

More appropriate than Toddlers in Tiaras.

**More illegitimate than Donald Trump's presidency
campaign!**

More seductive than defenestration.

**From the people who brought you the rest of this
magazine.**

Email us at cornelllunatic@gmail.com